

A-A (1 : 40)

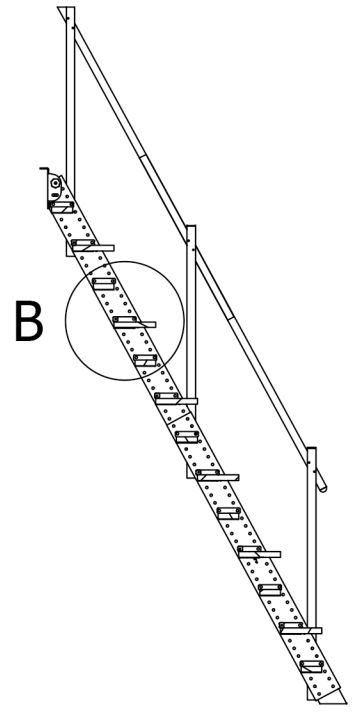

B (1 : 10)

